

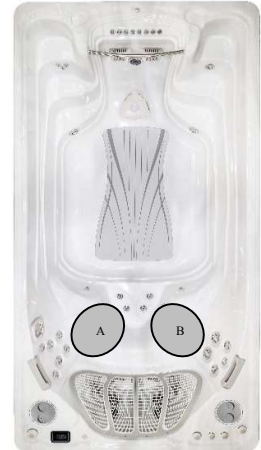

### Specification

<b>Seating Capacity</b> .....	2 Person
<b>Dimensions</b> .....	186" X 93" X 52.75" / (472.44 cm X 236.22 cm X 134 cm)
<b>Useable Swim Area Dimensions</b> .....	98" or 248 cm
<b>Dry Weight</b> .....	2,620 lbs / 1,189 kg
<b>Filled Weight (Spa Volume)</b> .....	19,454 lbs / 8,827 kg
<b>Water Capacity (Spa Volume)</b> .....	2,010 US gallons / 7,638 L
<b>Electronic Controls</b> .....	IN-K1000 SS Keypad (25 FOOT)
<b>Pump 1</b> .....	North America (60 Hz): 1- Speed, 3 HP, AMPS 10.0 Europe (50 Hz): 1- Speed, 2.5 HP, AMPS 8.6
<b>Pump 2</b> .....	North America (60 Hz): 1- Speed, 5 HP, AMPS 15.0 Europe (50 Hz): 1- Speed, 4 HP, AMPS 12.7
<b>Circulating Pump</b> .....	North America (60 Hz): 1- Speed, 1/12 HP, AMPS 0.65 Europe (50 Hz): 1- Speed, 1/15 HP, AMPS 0.66
<b>Total Seat Jets</b> .....	23
<b>Seat A Jets</b> .....	(2)-6020069; (2)-6030065; (2)-6030066; (4)-6015053
<b>Seat B Jets</b> .....	(1)-6030071; (2)-6030064; (2)-6030064; (4)-6015053
<b>Cool Down Jets</b> .....	(3)-6015053; (1)- 6035066;
<b>Massage Selectors</b> .....	YES
<b>Air Controls</b> .....	3
<b>Water Management System</b> .....	Pure Water System
<b>LED Lighting</b> .....	(1)-20 LED Large Light; (1)- Self Clean Plate
<b>Synthetic Cabinet Colours</b> .....	Driftwood, Midnight
<b>Acrylic Colours</b> .....	Silver Marble, Pure White, Alpine Mist
<b>Headrests</b> .....	(2)- 8" Pillow Waterfall Assembly
<b>Waterfalls</b> .....	YES
<b>Electrical Requirements</b> .....	North America (60 Hz): 240 V,40 AMPS GFCI RATED: 50 AMPS Europe (50 Hz):230V, 28A or suitably rated circuit breaker to comply with local electrical codes. RCD breakers with MC.
<b>Warranty</b> .....	10/5/3 Year limited
<b>Options/ Special Features</b> .....	1) Fitness and Fun: <ul style="list-style-type: none"> <li>• Aqua Rowing Kit</li> <li>• HP Cross Training Fitness Kit</li> <li>• 48" Stainless Steel Exercise Bar (Left Side Only)</li> </ul> 2)Covers: <ul style="list-style-type: none"> <li>• Safety Insulating Cover</li> <li>• Summer Cover with Tie Downs</li> <li>• Bi-Fold Cover Option</li> <li>• Rollaway Cover</li> <li>• Bracket for Rollaway Cover</li> <li>• Cover Remover (Standard)</li> <li>• Cover Remover Plus (Hydraulic)</li> </ul> 3)Hydrotherapy & Swim: <ul style="list-style-type: none"> <li>• Hydro Flex Air Therapy System- Heated**</li> <li>• White Water System**</li> </ul> (**Both System cannot be ordered on the same Swim Spa due to amperage Demand) 4)Cabinet: <ul style="list-style-type: none"> <li>• Replace Cabinet add Solid State Frame</li> </ul> 5)Bellagio Package Includes: <ul style="list-style-type: none"> <li>• Bellagio Hydro falls</li> <li>• Northern Lights + 2 LEDS</li> </ul> 6)Heating Options: <ul style="list-style-type: none"> <li>• Auxiliary Heating System By-pass Loop</li> <li>• Additional Heating (Optional on all Swim Spa)</li> </ul> 7)Other Popular Upgrades & Options: <ul style="list-style-type: none"> <li>• GFCI Including Subpanel</li> <li>• Tether Cord (Optional on all Swim Spa)</li> <li>• I Command System</li> <li>• Form Goggles</li> <li>• Northern Lights + 2 LEDS</li> <li>• EZ- Pure Ozonator (Must delete Pure Water)</li> <li>• 5 Tier Aqua Step</li> </ul>





### Massage Selector/Air Control Diagram

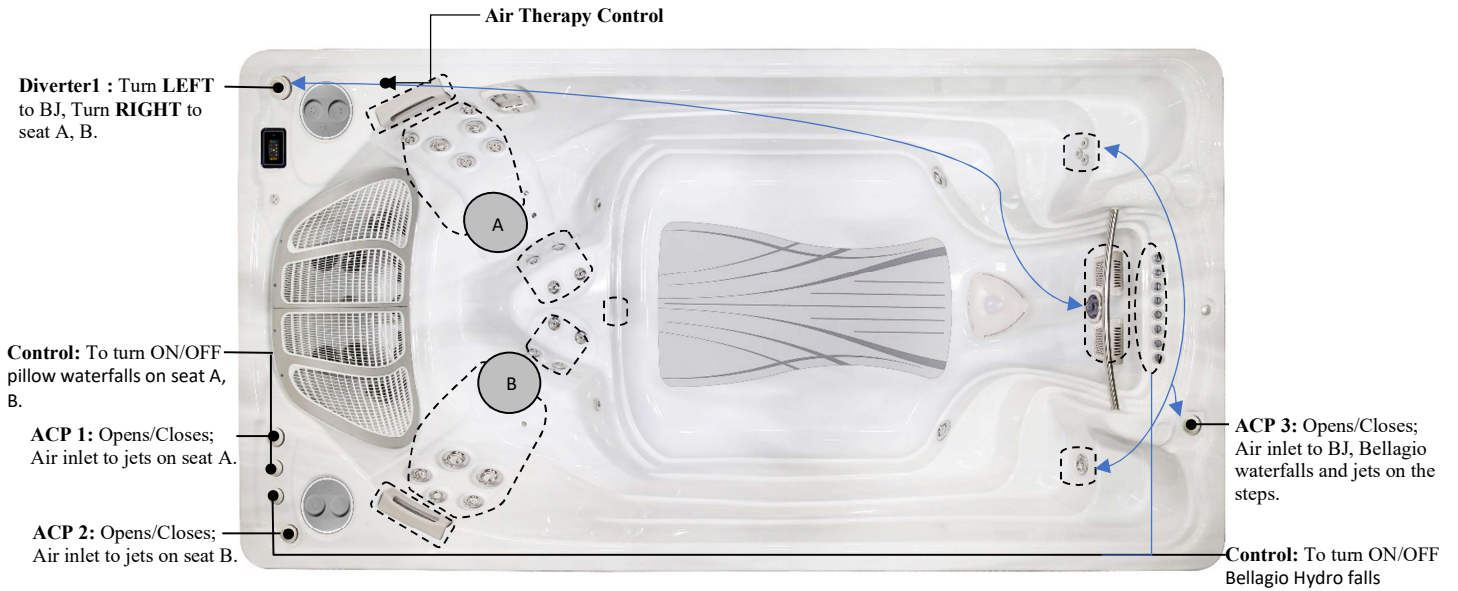

ACP- Air controller Pump  
 BJ – Buoyancy Jet  
 HFPC- Hydro Fall Pillow Control

### Seat Depth

A = 27.625" (70.17cm)

B = 25.00" (63.50cm)

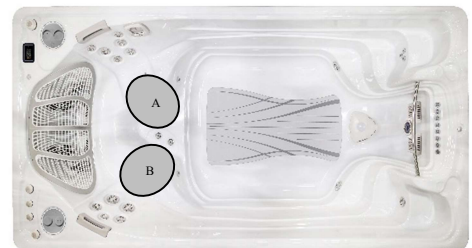

LISTED DIMENSIONS REPRESENT DISTANCE FROM THE TOP OF ACRYLIC TO LOWEST POINT IN THE SEAT. TOLERANCE  $\pm 1/16''$  (0.158CM)



### Dimensions

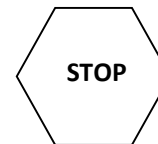
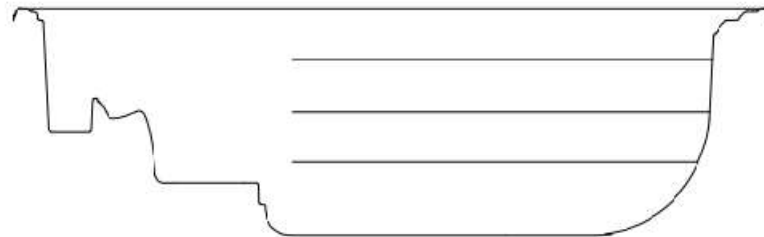
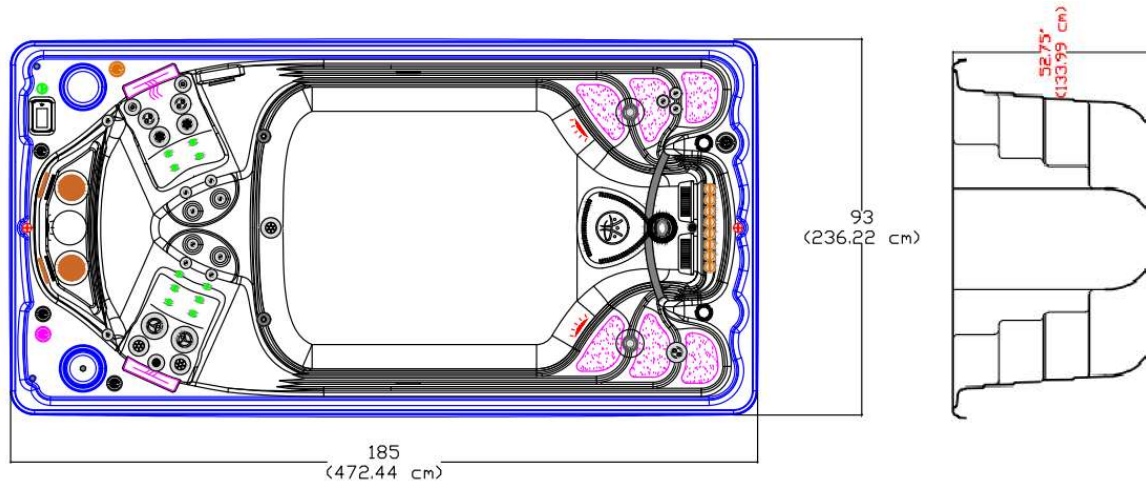

**IMPORTANT! Always measure each swim spa for exact dimensions BEFORE designing its foundational support and/or decking**



**NOTE:**

Dimensional tolerances are as follows due to variations in manufacturing:

Length / Width / Height(s): +/- 3/8"

Height Variance (side to side): +/- 1/4"



## HYDROPOOL –16EX - EXECUTIVE SPORT SWIM SPA



<b>Year:</b>	2023
<b>Model:</b>	HydroPool 16EX Executive Sport Swim Spa
<b>Size:</b>	186" X 93" X 52.75" / (472.44 cm X 236 cm X 134 cm)
<b>Series:</b>	HydroPool Executive Sport Series
<b>Main Keypad:</b>	IN. K1000 SS Keypad <b>(7005089)</b>
<b>Spa Pack and Heater:</b>	Heater: 4 KW 240 V (NA) & 3 KW 230V (EU) <b>Controller GECKO IN.YE-6 NA / IN.YE-5 EU</b>
<b>Pump #1:</b>	<b>North America (60 Hz):</b> 1- SP, 3 HP, AMPs – 10.0 <b>(6505161)</b> <b>Europe (50 Hz):</b> 1- SP, 2.5 HP, AMPs – 8.6 <b>(6510039)</b>
<b>Pump #2:</b>	<b>North America (60 Hz):</b> 1- Speed, 5 HP, AMPs 15.0 <b>(6505149)</b> <b>Europe (50 Hz):</b> 1- Speed, 4 HP, AMPs 12.7 <b>(6510041)</b>
<b>Circulation Pump:</b>	<b>North America (60 Hz):</b> 1- Speed, 1/12 HP, AMPs 0.65 <b>(6505147)</b> <b>Europe (50 Hz):</b> 1- Speed, 1/15 HP, AMPs 0.66 <b>(6510043)</b>
<b>Therapy Jets:</b>	11- CLUSTERSTORM JET- TWIN ROTO <b>(6015053)</b> , 2- MINISTORM JET – DIRECTIONAL <b>(6020069)</b> , 1- MINISTORM JET – GALAXY <b>(6020071)</b> , 2- POLYSTORM JET – RIFLED <b>(6030064)</b> , 2- POLYSTORM JET – PULSE MASSAGE <b>(6030065)</b> , 3- POLYSTORM JET – TWIN ROTO <b>(6030066)</b> , 2- POWERSTORM JET – TWISTER <b>(6035064)</b> ,
<b>Swim Jets:</b>	2- MONSOON (WHIRLPOOL) JET – <b>(6035066)</b> , 3- POWERSTORM (OVAL) JET – <b>(6035073)</b>
<b>Air Controls:</b>	(3) - Air Control <b>(4525089)</b>
<b>Diverter:</b>	(1) - 2" Water Diverter <b>(4525091)</b>
<b>Filters:</b>	(1) - 75 SQ. FT Filter <b>(4520008)</b>





### Specification

<b>Seating Capacity</b> .....	2 Person
<b>Dimensions</b> .....	186" X 93" X 52.75" / (472.44 cm X 236.22 cm X 134 cm)
<b>Useable Swim Area Dimensions</b> .....	98" or 248 cm
<b>Dry Weight</b> .....	2,620 lbs / 1,189 kg
<b>Filled Weight (Spa Volume)</b> .....	19,454 lbs / 8,827 kg
<b>Water Capacity (Spa Volume)</b> .....	2,010 US gallons / 7,638 L
<b>Electronic Controls</b> .....	IN-K1000 SS Keypad (25 FOOT)
<b>Pump 1</b> .....	North America (60 Hz): 1- Speed, 3 HP, AMPs 10.0 Europe (50 Hz): 1- Speed, 2.5 HP, AMPs 8.6
<b>Pump 2</b> .....	North America (60 Hz): 1- Speed, 5 HP, AMPs 15.0 Europe (50 Hz): 1- Speed, 4 HP, AMPs 12.7
<b>Pump 3</b> .....	North America (60 Hz): 1- Speed, 5 HP, AMPs 15.0 Europe (50 Hz): 1- Speed, 4 HP, AMPs 12.7
<b>Circulating Pump</b> .....	North America (60 Hz): 1- Speed, 1/12 HP, AMPs 0.65 Europe (50 Hz): 1- Speed, 1/15 HP, AMPs 0.66
<b>Total Seat Jets</b> .....	23
<b>Seat A Jets</b> .....	(2)-6020069; (2)-6030065; (2)-6030066; (4)-6015053
<b>Seat B Jets</b> .....	(1)-6030071; (2)-6030064; (2)-6035064; (4)-6015053
<b>Cool Down Seats</b> .....	(3)-6015053; (1)- 6035066
<b>Massage Selectors</b> .....	YES
<b>Air Controls</b> .....	3
<b>Water Management System</b> .....	Pure Water System
<b>LED Lighting</b> .....	(1)-20 LED Large Light; (1)- Self Clean Plate
<b>Synthetic Cabinet Colours</b> .....	Driftwood, Midnight
<b>Acrylic Colours</b> .....	Silver Marble, Alpine Mist, Pure White
<b>Headrests</b> .....	(2)- 8" Pillow Waterfall Assembly
<b>Waterfalls</b> .....	YES
<b>Electrical Requirements</b> .....	North America (60 Hz): 240 V,48 AMPs GFCI RATED: 60 AMPs Europe (50 Hz):230V, 28A or suitably rated circuit breaker to comply with local electrical codes. RCD breakers with MC.
<b>Warranty</b> .....	10/5/3 Year limited
<b>Options/ Special Features</b> .....	1) Fitness and Fun: <ul style="list-style-type: none"> <li>• Aqua Rowing Kit</li> <li>• HP Cross Training Fitness Kit</li> <li>• 48" Stainless Steel Exercise Bar (Left Side Only)</li> </ul> 2)Covers: <ul style="list-style-type: none"> <li>• Safety Insulating Cover</li> <li>• Summer Cover with Tie Downs</li> <li>• Bi-Fold Cover Option</li> <li>• Rollaway Cover</li> <li>• Bracket for Rollaway Cover</li> <li>• Cover Remover (Standard)</li> <li>• Cover Remover Plus (Hydraulic)</li> </ul> 3)Hydrotherapy & Swim: <ul style="list-style-type: none"> <li>• Hydro Flex Air Therapy System- Heated**</li> <li>• White Water System**</li> </ul> (**Both System cannot be ordered on the same Swim Spa due to amperage Demand) 4)Cabinet: <ul style="list-style-type: none"> <li>• Replace Cabinet add Solid State Frame</li> </ul> 5)Bellagio Package Includes: <ul style="list-style-type: none"> <li>• Bellagio Hydro falls</li> <li>• Northern Lights + 2 LEDS</li> </ul> 6)Heating Options: <ul style="list-style-type: none"> <li>• Auxiliary Heating System By-pass Loop</li> <li>• Additional Heating (Optional on all Swim Spa)</li> </ul> 7)Other Popular Upgrades & Options: <ul style="list-style-type: none"> <li>• GFCI Including Subpanel</li> <li>• Tether Cord (Optional on all Swim Spa)</li> <li>• I Command System</li> <li>• Form Goggles</li> <li>• Northern Lights + 2 LEDS</li> <li>• EZ- Pure Ozonator (Must delete Pure Water)</li> <li>• 5 Tier Aqua Step</li> </ul>





### Massage Selector/Air Control Diagram

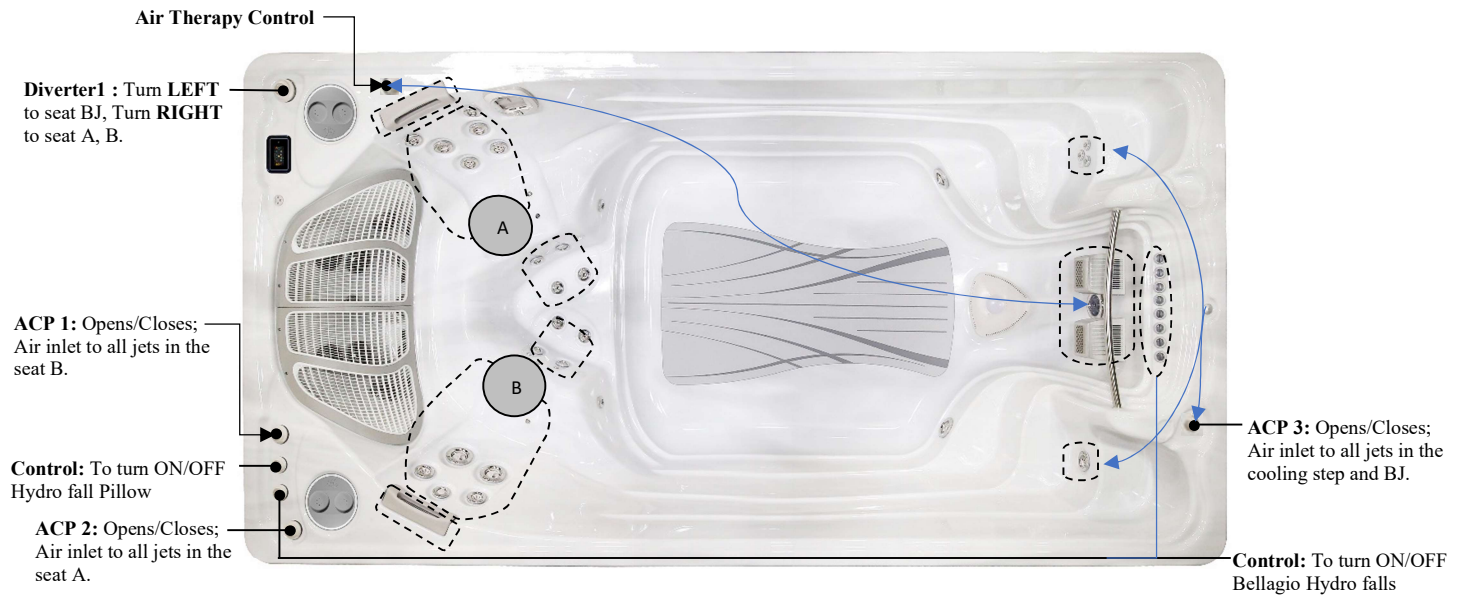

ACP- Air controller Pump  
 BJ- Buoyancy Jet  
 HFPC- Hydro Fall Pillow Control

### Seat Depth

A = 27.625" (70.17cm)

B = 25.00" (63.50cm)



LISTED DIMENSIONS REPRESENT DISTANCE FROM THE TOP OF ACRYLIC TO LOWEST POINT IN THE SEAT. TOLERANCE ±1/16" (0.158CM)





### Dimensions

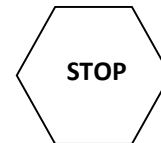
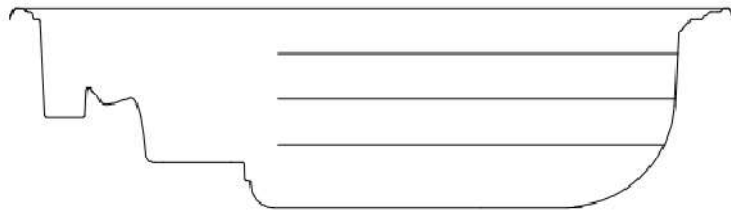
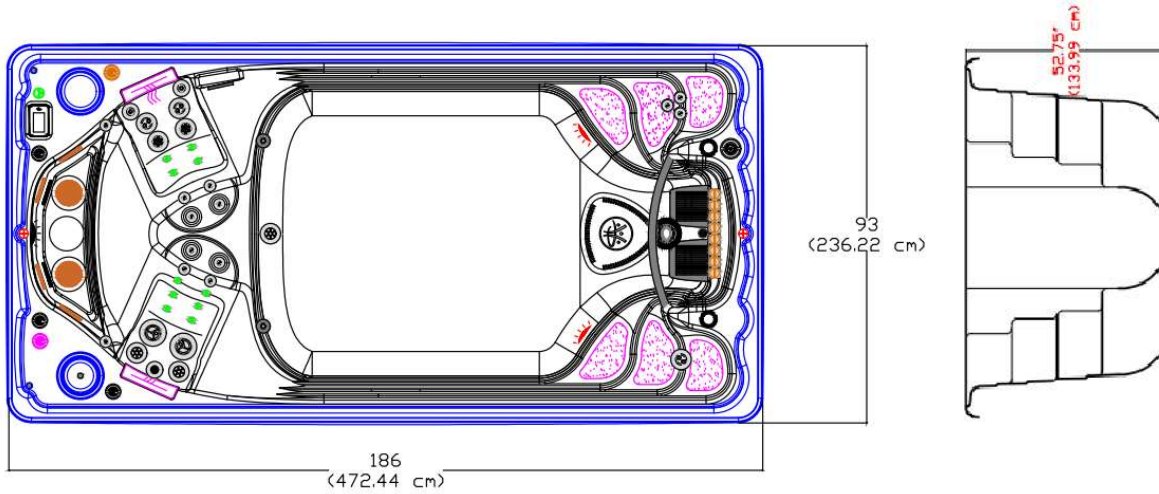

**IMPORTANT! Always measure each swim spa for exact dimensions BEFORE designing its foundational support and/or decking**

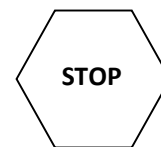

**NOTE:**

Dimensional tolerances are as follows due to variations in manufacturing:

Length / Width / Height(s): +/- 3/8"

Height Variance (side to side): +/- 1/4"



<b>Year:</b>	2023
<b>Model:</b>	HydroPool 16EX Executive Trainer Swim Spa
<b>Size:</b>	186"X 93" X 52.75" / (472.44 cm X 236 cm X 134 cm)
<b>Series:</b>	HydroPool Executive Trainer Series
<b>Main Keypad:</b>	IN. K1000 SS Keypad <b>(7005089)</b>
<b>Spa Pack and Heater:</b>	Heater: 4KW & 4 KW 240 V (NA), 4 & 3 KW 230V (EU) <b>Controller GECKO IN.YE-6 NA / IN.YE-5 EU</b>
<b>Pump #1:</b>	<b>North America (60 Hz):</b> 1- SP, 3 HP, AMPS – 10.0 <b>(6505161)</b> <b>Europe (50 Hz):</b> 1- SP, 2.5 HP, AMPS – 8.6 <b>(6510039)</b>
<b>Pump #2:</b>	<b>North America (60 Hz):</b> Variable Speed Motor <b>(6505162)</b> <b>Europe (50 Hz):</b> Variable Speed Motor <b>(6505162)</b>
<b>Pump #3:</b>	<b>North America (60 Hz):</b> Variable Speed Motor <b>(6505162)</b> <b>Europe (50 Hz):</b> Variable Speed Motor <b>(6505162)</b>
<b>Circulation Pump:</b>	<b>North America (60 Hz):</b> 1- Speed, 1/12 HP, AMPS 0.65 <b>(6505147)</b> <b>Europe (50 Hz):</b> 1- Speed, 1/15 HP, AMPS 0.66 <b>(6510043)</b>
<b>Therapy Jets:</b>	11- CLUSTERSTORM JET- TWIN ROTO <b>(6015053)</b> , 2- MINISTORM JET – DIRECTIONAL <b>(6020069)</b> , 1- MINISTORM JET – GALAXY <b>(6020071)</b> , 2- POLYSTORM JET – RIFLED <b>(6030064)</b> , 2- POLYSTORM JET – PULSE MASSAGE <b>(6030065)</b> , 3- POLYSTORM JET – TWIN ROTO <b>(6030066)</b> , 2- POWERSTORM JET – TWISTER <b>(6035064)</b>
<b>Swim Jets</b>	3- POWERSTORM (OVAL) JET – <b>(6035073)</b> , 2- WIDESTREAM SWIM JET – <b>(6035070)</b>
<b>Air Controls:</b>	(3) - Air Control <b>(4525089)</b>
<b>Diverter:</b>	(1) - 2" Water Diverter <b>(4525091)</b>
<b>Filters:</b>	(1) - 75 SQ.FT Filter <b>(4520008)</b>







### Specification

<b>Seating Capacity</b> .....	4 Person
<b>Dimensions</b> .....	220"X 93" X 52.75" / (558.80 cm X 236.22 cm X 133.99 cm)
<b>Useable Swim Area Dimensions</b> .....	132" or 335.28 cm
<b>7</b>	2,880 lbs / 1,307 kg
<b>Filled Weight (Spa Volume)</b> .....	22,800 lbs / 10,435 kg
<b>Water Capacity (Spa Volume)</b> .....	2,378 US gallons / 9,038 L
<b>Electronic Controls</b> .....	IN-K1000 SS Keypad (25 FOOT)
<b>Pump 1</b> .....	North America (60 Hz): 1- Speed, 3 HP, AMPs 10.0 Europe (50 Hz): 1- Speed, 2.5 HP, AMPs 8.6
<b>Pump 2</b> .....	North America (60 Hz): 1- Speed, 5 HP, AMPs 15.0 Europe (50 Hz): 1- Speed, 4 HP, AMPs 12.7
<b>Circulating Pump</b> .....	North America (60 Hz): 1- Speed, 1/12 HP, AMPs 0.65 Europe (50 Hz): 1- Speed, 1/15 HP, AMPs 0.66
<b>Total Seat Jets</b> .....	23
<b>Seat A Jets</b> .....	(2)-6020069; (2)-6030065; (2)-6030066;(4)-6015053
<b>Seat B Jets</b> .....	(1)-6020071; (2)-6030064; (2)-6035064;(4)-6015053
<b>Cooling Down Jets</b> .....	(3)-6015053; (1)-6035066
<b>Massage Selectors</b> .....	YES
<b>Air Controls</b> .....	3
<b>Water Management System</b> .....	See Options Below
<b>LED Lighting</b> .....	(3)-20 LED Large Light; (1)- Self Clean Plate
<b>Synthetic Cabinet Colours</b> .....	Driftwood, Midnight
<b>Acrylic Colours</b> .....	Silver Marble, Alpine Mist, Pure White
<b>Headrests</b> .....	(2)- 8" Pillow Waterfall Assembly
<b>Waterfalls</b> .....	YES
<b>Electrical Requirements</b> .....	North America (60 Hz): 240 V,40 AMPs GFCI RATED: 50 AMPs Europe (50 Hz):230V, 28A or suitably rated circuit breaker to comply with local electrical codes. RCD breakers with MC.
<b>Warranty</b> .....	10/5/3 Year limited
<b>Options/ Special Features</b> .....	1) Fitness and Fun: <ul style="list-style-type: none"> <li>• Aqua Rowing Kit</li> <li>• HP Cross Training Fitness Kit</li> <li>• 48" Stainless Steel Exercise Bar (Left Side Only)</li> </ul> 2)Covers: <ul style="list-style-type: none"> <li>• Safety Insulating Cover</li> <li>• Summer Cover with Tie Downs</li> <li>• Bi-Fold Cover Option</li> <li>• Rollaway Cover</li> <li>• Bracket for Rollaway Cover</li> <li>• Cover Remover (Standard)</li> <li>• Cover Remover Plus (Hydraulic)</li> </ul> 3)Hydrotherapy & Swim: <ul style="list-style-type: none"> <li>• Hydro Flex Air Therapy System- Heated**</li> <li>• White Water System**</li> </ul> (**Both System cannot be ordered on the same Swim Spa due to amperage Demand) 4)Cabinet: <ul style="list-style-type: none"> <li>• Replace Cabinet add Solid State Frame</li> </ul> 5)Bellagio Package Includes: <ul style="list-style-type: none"> <li>• Bellagio Hydro falls</li> <li>• Northern Lights + 2 LEDS</li> </ul> 6)Heating Options: <ul style="list-style-type: none"> <li>• Auxiliary Heating System By-pass Loop</li> <li>• Additional Heating (Optional on all Swim Spa)</li> </ul> 7)Other Popular Upgrades & Options: <ul style="list-style-type: none"> <li>• GFCI Including Subpanel</li> <li>• Tether Cord (Optional on all Swim Spa)</li> <li>• I Command System</li> <li>• Form Goggles</li> <li>• Northern Lights + 2 LEDS</li> <li>• EZ- Pure Ozonator (Must delete Pure Water)</li> <li>• 5 Tier Aqua Step</li> </ul>





### Massage Selector/Air Control Diagram



ACP- Air controller Pump  
 BJ- Buoyancy Jet  
 HFPC- Hydro Fall Pillow Control

### Seat Depth

A = 27.625" (70.17cm)

B = 25.00" (63.50cm)

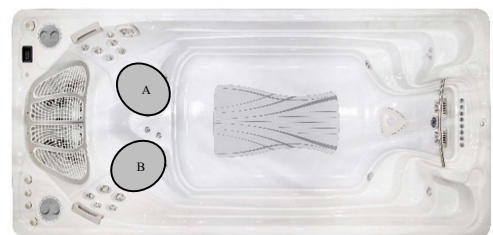

LISTED DIMENSIONS REPRESENT DISTANCE FROM THE TOP OF ACRYLIC TO LOWEST POINT IN THE SEAT. TOLERANCE ±1/16" (0.158CM)



Dimensions

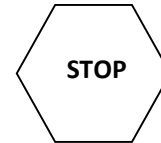
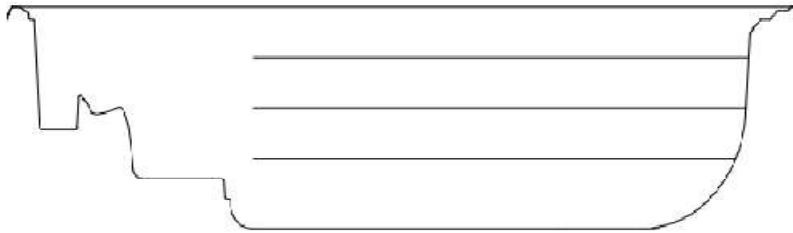
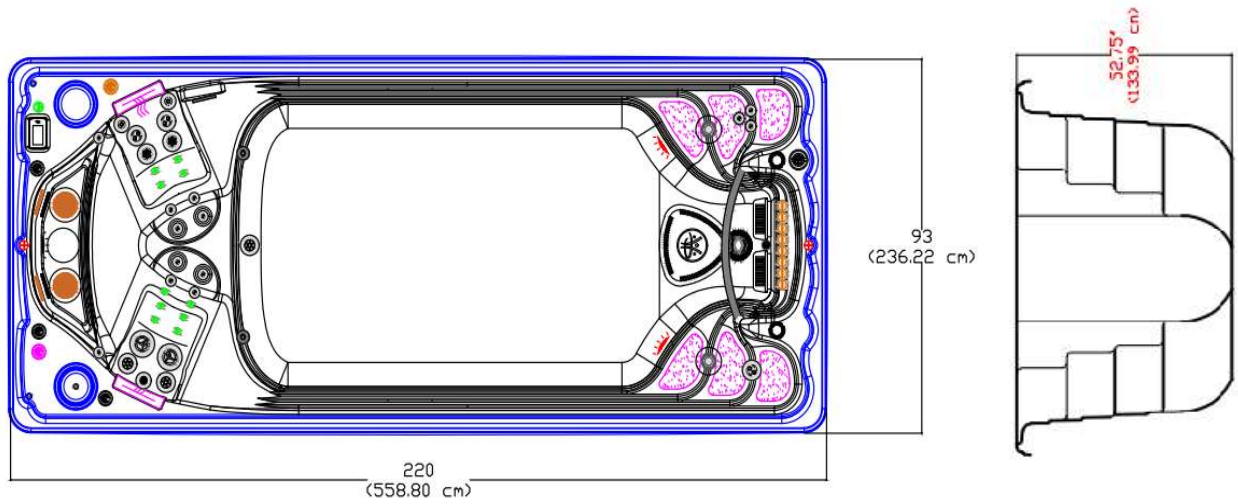

**IMPORTANT! Always measure each swim spa for exact dimensions BEFORE designing its foundational support and/or decking**

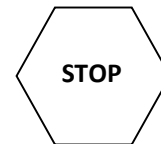

**NOTE:**

Dimensional tolerances are as follows due to variations in manufacturing:

Length / Width / Height(s): +/- 3/8"

Height Variance (side to side): +/- 1/4"



## HYDROPOOL –19EX EXECUTIVE SPORT SWIM SPA



<b>Year:</b>	2023
<b>Model:</b>	HydroPool 19EX Executive Sport Swim Spa
<b>Size:</b>	220" X 93" X 52.75" / (558.80 cm X 236.22 cm X 133.99 cm)
<b>Series:</b>	HydroPool Executive Sport Series
<b>Main Keypad:</b>	IN. K1000 SS Keypad <b>(7005089)</b>
<b>Spa Pack and Heater:</b>	Heater: 4 KW 240 V (NA) & 3 KW 230V (EU) <b>Controller GECKO IN.YE-6 NA / IN.YE-5 EU</b>
<b>Pump #1:</b>	<b>North America (60 Hz):</b> 1- SP, 3 HP, AMPS – 10.0 <b>(6505161)</b> <b>Europe (50 Hz):</b> 1- SP, 2.5 HP, AMPS – 8.6 <b>(6510039)</b>
<b>Pump #2:</b>	<b>North America (60 Hz):</b> 1- Speed, 5 HP, AMPS 15.0 <b>(6505149)</b> <b>Europe (50 Hz):</b> 1- Speed, 4 HP, AMPS 12.7 <b>(6510044)</b>
<b>Circulation Pump:</b>	<b>North America (60 Hz):</b> 1- Speed, 1/12 HP, AMPS 0.65 <b>(6505147)</b> <b>Europe (50 Hz):</b> 1- Speed, 1/15 HP, AMPS 0.66 <b>(6510043)</b>
<b>Therapy Jets:</b>	11- CLUSTERSTORM JET- TWIN ROTO <b>(6015053)</b> , 2- MINISTORM JET – DIRECTIONAL <b>(6020069)</b> , 1- MINISTORM JET – GALAXY <b>(6020071)</b> , 3- POLYSTORM JET – RIFLED <b>(6030064)</b> , 2- POLYSTORM JET – PULSE MASSAGE <b>(6030065)</b> , 2- POLYSTORM JET – TWIN ROTO <b>(6030066)</b> , 2- POWERSTORM JET – TWISTER <b>(6035064)</b> ,
<b>Swim Jets:</b>	2- MONSOON (WHIRLPOOL) JET – <b>(6035066)</b> , 3- POWERSTORM (OVAL) JET – <b>(6035073)</b>
<b>Air Controls:</b>	(3) - Air Control <b>(4525089)</b>
<b>Diverter:</b>	(1) - 2" Water Diverter <b>(4525091)</b>
<b>Filters:</b>	(1) - 75 SQ.FT Filter <b>(4520008)</b>





### Specification

<b>Seating Capacity</b> .....	4 Person
<b>Dimensions</b> .....	220" X 93" X 52.75" / (558.80 cm X 236.2 cm X 133.99 cm)
<b>Useable Swim Area Dimensions</b> .....	132" or 335.28 cm
<b>Dry Weight</b> .....	2,880 lbs / 1,307 kg
<b>Filled Weight (Spa Volume)</b> .....	22,800 lbs / 10,435 kg
<b>Water Capacity (Spa Volume)</b> .....	2,378 US gallons / 9,038 L
<b>Electronic Controls</b> .....	IN-K1000 SS Keypad (25 FOOT)
<b>Pump 1</b> .....	North America (60 Hz): 1- Speed, 3 HP, AMPS 10.0 Europe (50 Hz): 1- Speed, 2.5 HP, AMPS 8.6
<b>Pump 2</b> .....	North America (60 Hz): 1- Speed, 5 HP, AMPS 15.0 Europe (50 Hz): 1- Speed, 4 HP, AMPS 12.7
<b>Pump 3</b> .....	North America (60 Hz): 1- Speed, 5 HP, AMPS 15.0 Europe (50 Hz): 1- Speed, 4 HP, AMPS 12.7
<b>Circulating Pump</b> .....	North America (60 Hz): 1- Speed, 1/12 HP, AMPS 0.65 Europe (50 Hz): 1- Speed, 1/15 HP, AMPS 0.66
<b>Total Seat Jets</b> .....	23
<b>Seat A Jets</b> .....	(2)-6020069; (2)-6030065; (2)-6030066;(4)-6015053;
<b>Seat B Jets</b> .....	(1)-6020071; (2)-6030064; (2)-6035064;(4)-6015053;
<b>Cooling Down Steps</b> .....	(3)-6015053; (1)-6030066
<b>Massage Selectors</b> .....	YES
<b>Air Controls</b> .....	3
<b>Water Management System</b> .....	Pure Water System
<b>LED Lighting</b> .....	(1)-20 LED Large Light; (1)- Self Clean Plate
<b>Synthetic Cabinet Colours</b> .....	Driftwood, Midnight
<b>Acrylic Colours</b> .....	Silver Marble, Alpine Mist, Pure White
<b>Headrests</b> .....	(2)- 8" Pillow Waterfall Assembly
<b>Waterfalls</b> .....	YES
<b>Electrical Requirements</b> .....	North America (60 Hz): 240 V,48 AMPS GFCI RATED: 60 AMPS Europe (50 Hz):230V, 28A or suitably rated circuit breaker to comply with local electrical codes. RCD breakers with MC.
<b>Warranty</b> .....	10/5/3 Year limited
<b>Options/ Special Features</b> .....	1) Fitness and Fun: <ul style="list-style-type: none"> <li>• Aqua Rowing Kit</li> <li>• HP Cross Training Fitness Kit</li> <li>• 48" Stainless Steel Exercise Bar (Left Side Only)</li> </ul> 2)Covers: <ul style="list-style-type: none"> <li>• Safety Insulating Cover</li> <li>• Summer Cover with Tie Downs</li> <li>• Bi-Fold Cover Option</li> <li>• Rollaway Cover</li> <li>• Bracket for Rollaway Cover</li> <li>• Cover Remover (Standard)</li> <li>• Cover Remover Plus (Hydraulic)</li> </ul> 3)Hydrotherapy & Swim: <ul style="list-style-type: none"> <li>• Hydro Flex Air Therapy System- Heated**</li> <li>• White Water System**</li> </ul> (**Both System cannot be ordered on the same Swim Spa due to amperage Demand) 4)Cabinet: <ul style="list-style-type: none"> <li>• Replace Cabinet add Solid State Frame</li> </ul> 5)Bellagio Package Includes: <ul style="list-style-type: none"> <li>• Bellagio Hydro falls</li> <li>• Northern Lights + 2 LEDS</li> </ul> 6)Heating Options: <ul style="list-style-type: none"> <li>• Auxiliary Heating System By-pass Loop</li> <li>• Additional Heating (Optional on all Swim Spa)</li> </ul> 7)Other Popular Upgrades & Options: <ul style="list-style-type: none"> <li>• GFCI Including Subpanel</li> <li>• Tether Cord (Optional on all Swim Spa)</li> <li>• I Command System</li> <li>• Form Goggles</li> <li>• Northern Lights + 2 LEDS</li> <li>• EZ- Pure Ozonator (Must delete Pure Water)</li> <li>• 5 Tier Aqua Step</li> </ul>





### Massage Selector/Air Control Diagram



ACP- Air controller Pump  
 BJ- Buoyancy Jet  
 HFPC- Hydro Fall Pillow Control

### Seat Depth

A = 27.96" (71.01cm)

B = 25.91" (63.81cm)

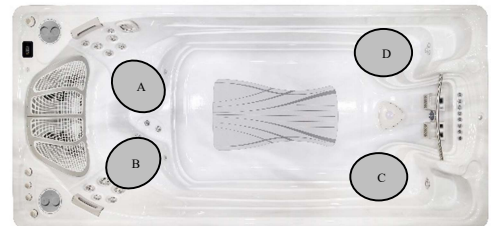

LISTED DIMENSIONS REPRESENT DISTANCE FROM THE TOP OF ACRYLIC TO LOWEST POINT IN THE SEAT. TOLERANCE ±1/16" (0.158CM)





### Dimensions

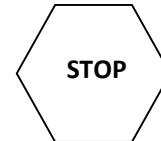
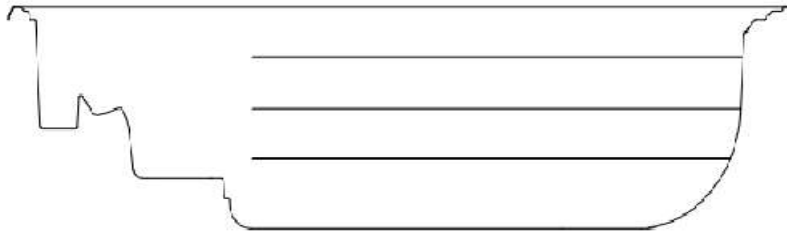
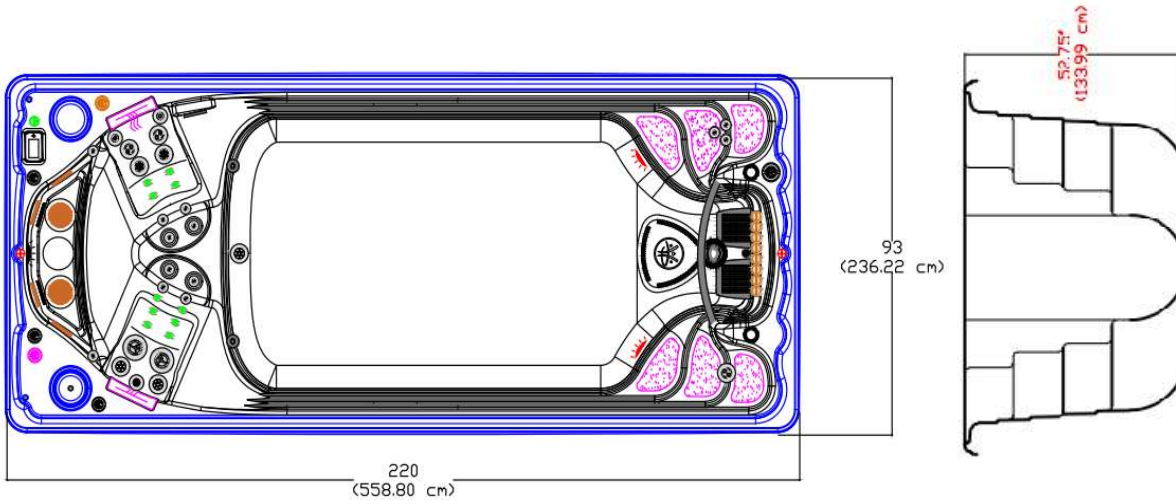

**IMPORTANT! Always measure each swim spa for exact dimensions BEFORE designing its foundational support and/or decking**

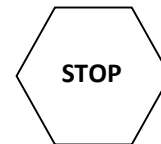

**NOTE:**

Dimensional tolerances are as follows due to variations in manufacturing:

Length / Width / Height(s): +/- 3/8"

Height Variance (side to side): +/- 1/4"



<b>Year:</b>	2023
<b>Model:</b>	HydroPool 19EX Executive Trainer Swim Spa
<b>Size:</b>	220" X 93" X 52.75" / (558.80 cm X 236.22 cm X 133.99 cm)
<b>Series:</b>	HydroPool Executive Trainer Series
<b>Main Keypad:</b>	IN. K1000 SS Keypad <b>(7005089)</b>
<b>Spa Pack and Heater:</b>	Heater: 4KW & 4 KW 240 V (NA), 4 & 3 KW 230V (EU) <b>Controller GECKO IN.YE-6 NA / IN.YE-5 EU</b>
<b>Pump #1:</b>	<b>North America (60 Hz):</b> 1- SP, 3 HP, AMPS – 10.0 <b>(6505161)</b> <b>Europe (50 Hz):</b> 1- SP, 2.5 HP, AMPS – 8.6 <b>(65010041)</b>
<b>Pump #2:</b>	<b>North America (60 Hz):</b> Variable Speed Motor <b>(6505162)</b> <b>Europe (50 Hz):</b> Variable Speed Motor <b>(6505162)</b>
<b>Pump #3:</b>	<b>North America (60 Hz):</b> Variable Speed Motor <b>(6505162)</b> <b>Europe (50 Hz):</b> Variable Speed Motor <b>(6505162)</b>
<b>Circulation Pump:</b>	<b>North America (60 Hz):</b> 1- Speed, 1/12 HP, AMPS 0.65 <b>(6505147)</b> <b>Europe (50 Hz):</b> 1- Speed, 1/15 HP, AMPS 0.66 <b>(6510043)</b>
<b>Therapy Jets:</b>	11- CLUSTERSTORM JET- TWIN ROTO <b>(6015053)</b> , 2- MINISTORM JET – DIRECTIONAL <b>(6020069)</b> , 1- MINISTORM JET – GALAXY <b>(6020071)</b> , 2- POLYSTORM JET – RIFLED <b>(6030064)</b> , 2- POLYSTORM JET – PULSE MASSAGE <b>(6030065)</b> , 3- POLYSTORM JET – TWIN ROTO <b>(6030066)</b> , 2- POWERSTORM JET – TWISTER <b>(6035064)</b> ,
<b>Swim Jets</b>	3- POWERSTORM (OVAL) JET – <b>(6035073)</b> , 2- WIDESTREAM SWIM JET – <b>(6035070)</b>
<b>Air Controls:</b>	(3) - Air Control <b>(4525089)</b>
<b>Diverter:</b>	(1) - 2" Water Diverter <b>(4525091)</b>
<b>Filters:</b>	(1) - 75 SQ. FT Filter <b>(4520008)</b>

